

Open for step-by-step setup instructions.
Let's get started.

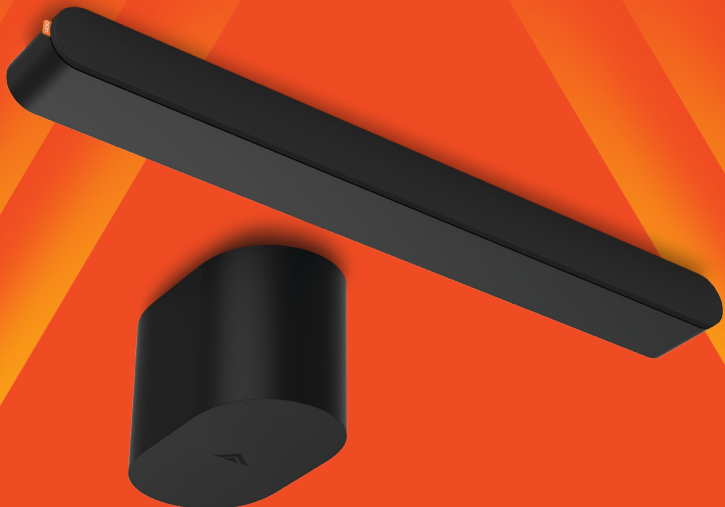

VIZIO 2.1 SE Soundbar Quick Setup Guide

VIZIO

Your sound. Your way.

Access audio controls with VIZIO Mobile.

*VIZIO Mobile app and VIZIO Account required for control of soundbar functionality, settings, and to receive system updates. Scan to download.

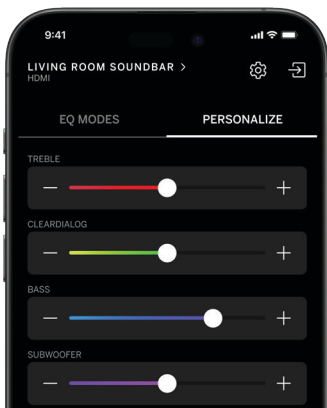

If you do not have a smart phone, your TV remote will also control soundbar volume, mute, and unmute.

Need more help?
Scan for additional support and documentation.



Exclusive for VIZIO TV Simplified setup and control for VIZIO TV owners.



VIZIO QuickFit
A proprietary mounting solution that enables elegant, tool-free installation of your soundbar with compatible VIZIO TVs.

Audio Control Menu
Press the Settings button on your VIZIO TV remote and select ALL SETTINGS > AUDIO to get started.

Learn more at vizio.com/quickfit

Get to know your soundbar

Using Bluetooth® to stream music

Press and hold the Bluetooth button on your soundbar and release after 2 seconds OR press the Bluetooth button found within the VIZIO Mobile App to initiate Bluetooth pairing. Open Bluetooth settings on your mobile device. Select your VIZIO Soundbar in "other devices" to pair and connect. Once paired to the soundbar, you can begin streaming music, podcasts, and more.

Understanding HDMI® ARC/eARC

Your TV may have two or more HDMI ports, only one will be labeled HDMI ARC or HDMI eARC. For optimal audio performance, be sure to connect the HDMI cable to your TV's HDMI ARC or HDMI eARC port.

Your soundbar features HDMI eARC for the highest quality audio formats like full-bandwidth Dolby Atmos audio. To unlock your soundbar's full potential, be sure that HDMI CEC and eARC are turned on in your TV settings menu. Refer to your TV user guide for details.

Controlling your soundbar and TV with one remote

Use your existing TV remote to power on your TV. The soundbar will automatically wake from sleep mode. Your TV remote will now control soundbar volume, mute, and unmute.

1 Position

Position the soundbar (A) and subwoofer (B) as shown in the image below.

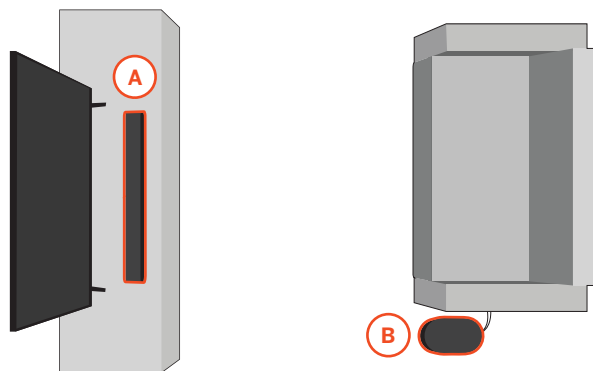

2 Connect

Connect the soundbar to the HDMI ARC or eARC port on your TV with the included HDMI cable.

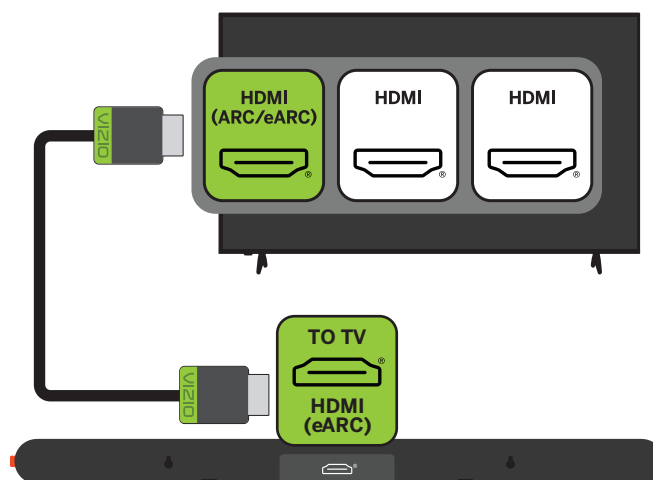

3 Plug In

Plug in power cables to the soundbar and subwoofer.

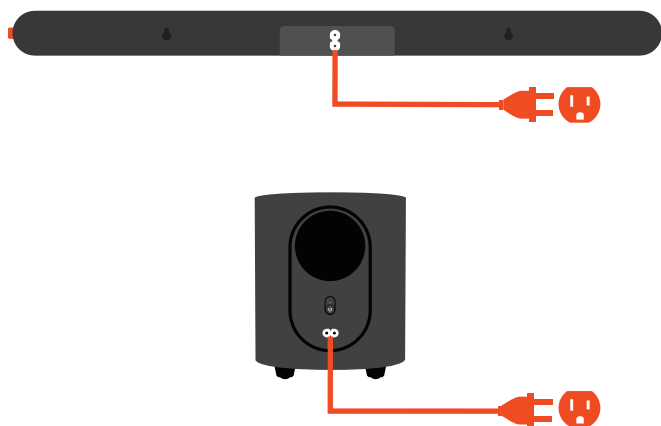

 A sound will play when the soundbar powers on for the first time and the front LED light will turn on.

4 Use VIZIO Mobile to control your soundbar

Download VIZIO Mobile and create a VIZIO Account.



1. Activate Bluetooth on your phone while standing next to your soundbar.
2. Open VIZIO Mobile to pair and connect to the soundbar. The app automatically recognizes your soundbar for the first hour after installation.
3. After one hour, press and hold the Bluetooth button on your soundbar. Release after 5 seconds to initiate the pairing process for up to 3 minutes.
4. Once paired, adjust audio levels like bass, treble, height, and dialogue.

 If you do not have a smart phone, your TV remote will also control soundbar volume, mute, and unmute.